

MUR D'IMAGES OUTDOOR

Product Component

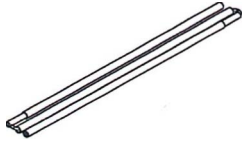

support pole x1



connection part x6

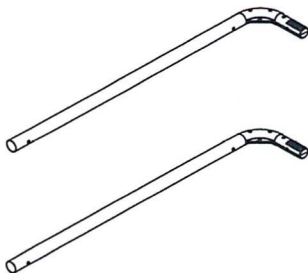

805mm pole x2

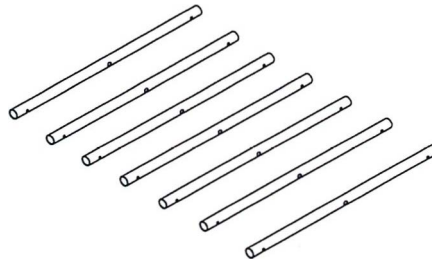

730mm pole x7

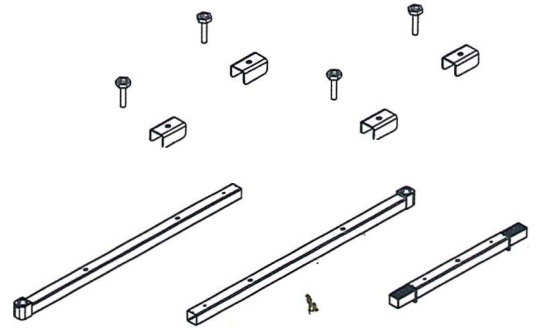

bolt x4 iron pad x4 pole x3

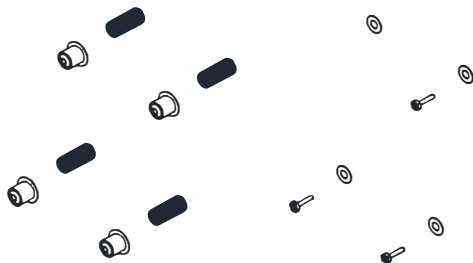

iron spring x4
plastic pad x4

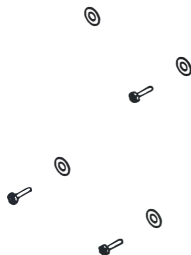

bolt x4
iron pad x4

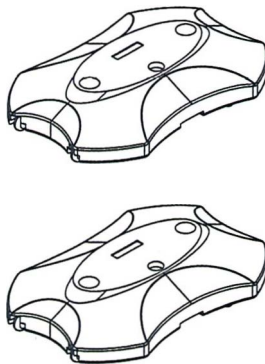

water base x2

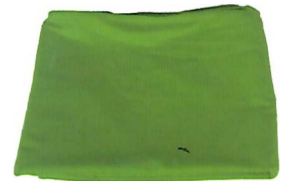

fabric graphic x1

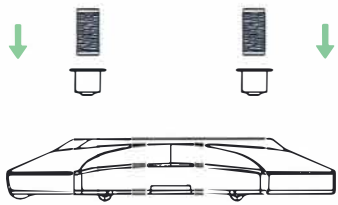

1. Put springs and plastic pads in the holes

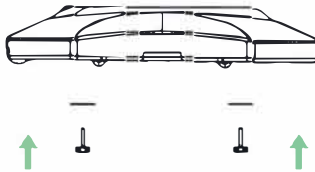

2. Put the iron pads in the holes ,then use bolts to fix the springs.

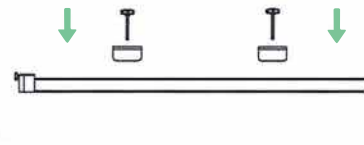

3. Put the iron pads on the pole ,then insert bolts into the holes.

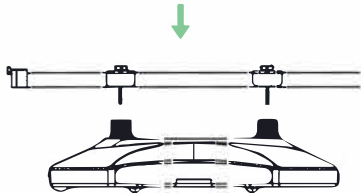

4. Screw the bolts into the springs.

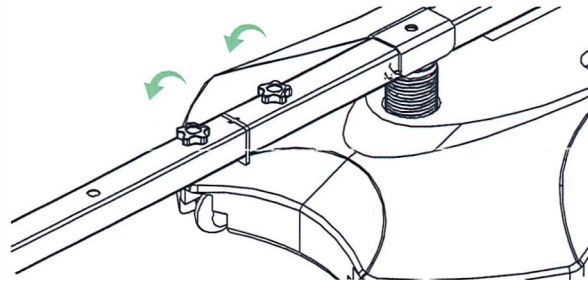

5. Screw the bolts to connect the poles.

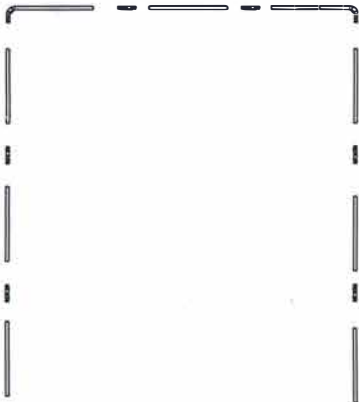

6. Press the spring button to snap the poles.

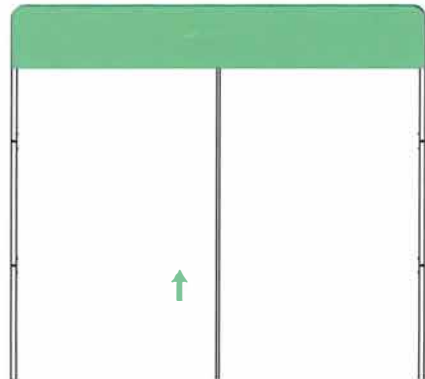

7. Lean the frame and pull the graphic to cover one fifth of frame,then insert the support pole.

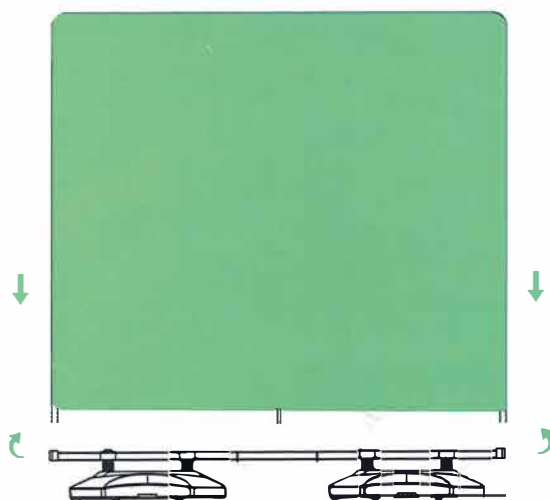

8. Connect the frame ,then screw the knobs to fix the poles.